











Rating Data

1. Nominal capacity C₅:
 2. Nominal voltage:
 3. Discharge current:
 4. Nominal S.G. of electrolyte* Type PzQ:
 5. Rated temperature:
 6. Nominal electrolyte level:
- * Will be reached within the first 10 cycles.

See type plate
2.0 V x No of cells
C₅/5h
1.32 kg/l
30°C
up to electrolyte level mark "max."

 <ul style="list-style-type: none"> • Observe operating instructions and display in a visible place near the battery. Work on batteries to be carried out by qualified personal only. 	 <ul style="list-style-type: none"> • Risk of explosion and fire, avoid short circuits. • Avoid electrostatic charges and discharges/sparks.
 <ul style="list-style-type: none"> • No smoking! No open flame, embers or sparks in the vicinity of the battery to avoid risk of explosion and fire. 	 <ul style="list-style-type: none"> • Electrolyte is highly corrosive!
 <ul style="list-style-type: none"> • While working on batteries wear protective eyeglasses and clothing! • Observe accident prevention regulations as well as EN 62485-3 and EN 50110-1. 	 <ul style="list-style-type: none"> • Caution! Dangerous electrical voltage! • Metal parts of the battery are always live; therefore do not place items or tools on the battery!
 <ul style="list-style-type: none"> • Acid splashes in the eyes or on the skin must be washed with plenty of clean water. • Then consult a doctor immediately! • Clothing contaminated by acid should be washed in water. 	 <p style="text-align: center; font-size: 2em; font-weight: bold;">Pb</p>
 <ul style="list-style-type: none"> • Warning of battery hazards. 	
 <ul style="list-style-type: none"> • Only use suitable handling equipment, e.g. lifting gear in accordance with VDI 3616. • Cells are very heavy. Make sure they are installed securely. • Only use suitable means of transport. 	 <p style="text-align: right; font-size: 0.8em;">10/71260 10/2019 Rev.2</p>

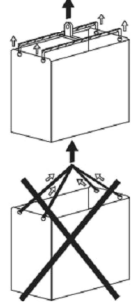
Ignoring the operation instructions, repair with non-original parts, unauthorized modifications or using additives for the electrolyte will render the warranty void.

1. Commissioning filled and charged batteries

The battery should be inspected to ensure it is in perfect physical condition; the battery harness has to have reliable contact and has to be connected with correct polarity. Otherwise the battery, vehicle or battery charger may be damaged.

For the assembly of cables and harness cables only use the original bolts. Attach the harness to the strain release cable clamp.

Harness and connector bolts should be tightened to the following torque settings:

M 10 connector	25 ± 2 Nm
----------------	-----------

Bolts with thread lock may be used up to 5 times. For safety reasons new bolts with thread lock are recommended.

In case the interval between delivery (see manufacturing date on type plate) and commissioning is longer than 8 weeks or the electrolyte level sensor float indicator is indicating low electrolyte level (see table, point 3.1.1), the electrolyte level has to be checked. For the removal of the water refilling plugs, only the appropriate tool must be used. Otherwise, the floats of plugs may be permanently damaged, which can cause overflow of the electrolyte. If the electrolyte level is below the top of the separator, it must first be topped up to this height with purified water (IEC 62877-1: 2016). The battery is then charged (see point 2.2). The electrolyte should be topped up to the specified level with purified water.

2. Operation

EN 62485-3 "Safety requirements for secondary batteries and battery installations Traction batteries" is the standard, which applies for the operation of traction batteries in industrial trucks.

2.1 Discharging

Be sure that all ventilation holes are not sealed or covered. Electrical connections (e.g. plugs) must only be made or broken in the open circuit condition. To achieve the optimum life for the battery, operating discharges of more than 70% of the rated capacity must be avoided (deep discharge). This corresponds to an electrolyte specific gravity of 1.16 kg/l at 30°C at the end of the discharge. Discharged batteries must be recharged immediately and must not be left discharged. This also applies to partially discharged batteries. The discharge indicator on the truck/vehicle must be set correctly. The setting depends on the discharge indicator brand and must be equivalent to a discharge with a current of I₅ to a final voltage of 1.92Vpc for 70% DOD. Please refer to EnerSys® application engineer in case of AGV applications.

2.2 Charging

Only direct current must be used for charging. For IRONCLAD® batteries, procedures in accordance with EN 41773-1 and EN 41774 are permitted. All batteries with a nominal energy >12kWh should be recharged with Airmixing profiles. Connect the battery to an assigned charger, suitable for the rating and specification of the battery (e.g. cable

cross section, etc.), in order to avoid overloading of the electric cables and contacts, unacceptable gassing and the escape of electrolyte from the cells. In the gassing stage, the current limits given in EN 62485-3 must not be exceeded. If the charger was not purchased together with the battery it is best to have the charger's, cables and plugs suitability checked by the manufacturer's service department. When charging, proper provision must be made for venting of the charging gases.

Truck doors, battery container lids and covers of battery compartments must be opened or removed. During the charge in the truck, those from the manufacturers' specified vents have to be opened. In all cases, the ventilation must comply with EN 62485-3 standard. The vent plugs should remain on the cells and be kept closed. With the charger switched off, connect the battery, ensuring that the polarity is correct (positive to positive, negative to negative). Then switch on the charger.

During the charging process, the temperature of the electrolyte rises by about 10°C, so charging should only begin if the electrolyte temperature is below 45°C. The electrolyte temperature of batteries should be at least +10°C before charging otherwise a full charge would not be achieved. A charge is finished when the specific gravity of the electrolyte and the battery voltage have remained constant for two hours. EnerSys® chargers automatically indicate end of charge. Batteries fitted with electrolyte circulation system: in case a pump fault is indicated, check that the piping system is connected and examine the piping circuit for leaks or defects (see point 3.4). The air pipe should never be removed during charge.

2.3 Equalizing charge

Equalizing charges are used to safeguard the life of the battery and to maintain its capacity. They are necessary after deep discharges, repeated incomplete recharges and charges to an IU characteristic curve. Equalizing charges are carried out following normal charging. The charging current must not exceed 5 A/100 Ah of rated capacity (end of charge - see point 2.2). **Watch the temperature!**

2.4 Temperature

An electrolyte temperature of 30°C is specified as the rated temperature. Higher temperatures shorten the life of the battery; lower temperatures reduce the capacity available. 55°C is the upper temperature limit and is not acceptable as an operating temperature.

2.5 Electrolyte

The rated specific gravity (S. G.) of the electrolyte is related to a temperature of 30°C and the nominal electrolyte level in the cell in fully charged condition.

Higher temperatures reduce the specified gravity of the electrolyte, lower temperatures increase it. The temperature correction factor is -0.0007 kg/l per °C, e.g. an electrolyte specific gravity of 1.31 kg/l at 45°C corresponds to an S.G. of 1.32 kg/l at 30°C. The electrolyte must conform to the purity regulations in IEC 62877-2: 2016.

3. Maintenance

3.1 Daily

Charge the battery after every discharge. The electrolyte level must not fall below the top of the separator or the electrolyte "min" level mark.
NO WATERING IN THE FIRST 10 CYCLES.

3.1.1 Filling level sensors

In the case of batteries with filling level sensors, the LED should be observed daily.

LED green	level OK
LED red blinking	level too low

Do not top up the cells even when electrolyte level sensor shows a red blinking LED during first 10 cycles.

Check the electrolyte level by the position of the float indicator of the water filling plug and top-up with demineralized water at the end of the charge. Since the display always refers to a selected reference cell, please

also pay attention to the additional instructions under point 3.3.

3.2 Weekly

Visual inspection after recharging for signs of dirt and mechanical damage to all component parts of the battery, pay particular attention to the battery charging plugs and cables. By special applications with charge with a IU characteristic curve an equalizing charge must be carried out (see point 2.3).

3.3 Monthly

At the end of the charge, the voltages of all cells should be measured with the charger switched on, and recorded. After charging has been completed, the electrolyte density, electrolyte temperature as well as the filling level (when filling level sensors are used) of all cells are to be measured and recorded. If significant changes from earlier measurements or differences between the cells are found further testing and maintenance by the service department should be requested. This should be done following a complete charge and minimum of 2 hours rest time.

Measure and record:

- Total voltage
- Voltage per cell
- If the voltage readings are irregular, also check the S.G. of each cell

3.4 Annually

In accordance with EN 1175-1 at least once per year, an electrical specialist must check the insulation resistance of the truck and the battery. The tests on the insulation resistance of the battery must be conducted in accordance with EN 1987-1. The insulation resistance of the battery thus determined must not be below a value of 50 Ohm per Volt of nominal voltage, in compliance with EN 62485-3. For batteries up to 20 V nominal voltage, the minimum value is 1,000 Ohm.

Batteries fitted with electrolyte circulation system: the filter of the air pump has to be checked at least during the annual maintenance and eventually to be cleaned or replaced. Depending on the environment, a higher frequency for filter check than once per year may be necessary. Earlier replacement of the filter is necessary if for undefined reasons (no leaks in the air pipes) the defect signal of the air mixing system on the charger or on the battery (on DC air pump or remote signal) is illuminated. During the annual maintenance, check the correct operation of the air pump.

4. Care of the battery

The battery should always be kept clean and dry to prevent tracking currents. Cleaning must be done in accordance with the ZVEI code of practice "The Cleaning of Vehicle Traction batteries". Any liquid in the battery tray must be extracted and disposed of in the prescribed manner. Damage to the insulation of the tray should be repaired after cleaning, to ensure that the insulation value complies with EN 62485-3 and to prevent tray corrosion. If it is necessary to remove cells, it is best to call in EnerSys® service department for this. Never use (apply) mineral grease on the battery, the sealing material of the terminal is incompatible and it can be permanently damaged. If it's necessary, use (apply) the silicone grease with TPFE.

5. Storage

If batteries are taken out of service for a lengthy period, they should be stored in the fully charged condition in a dry, frost-free room. To ensure the battery is always ready for use a choice of charging methods can be made:

1. a monthly equalizing charge as in point 2.3, or
2. float charging at a charging voltage of 2.29 V x the number of cells.

The storage time should be taken into account when considering the life of the battery.

6. Malfunctions

If malfunctions are found on the battery or the charger, EnerSys® service should be called in immediately. The measurements taken in point 3.3 will facilitate fault finding and their elimination.

A service contract with us will make it easier to detect and correct faults in good time.

Standard and optional equipment

Water refilling system	■
Electrolyte circulation*	■
Wi-iQ®	■
Level sensor	+

■ Standard
+ Option

* Optional for the battery below 12kWh

Water refilling system

1. Application

The water refilling system is used to automatically maintain the nominal electrolyte levels.

The charging gasses escape through the vent on each cell.

NO WATERING IN THE FIRST 10 CYCLES.

2. Function

A valve and a float together control the topping up process and maintain the correct water level in each cell.

The valve allows the flow of water into each cell and the float closes the valve when the correct water level has been reached.

For fault-free operation of the water refilling system, please note the instructions below:

2.1 Manual or automatic connection

The battery should be topped up shortly before completion of a full charge, as at this point the battery has reached a defined operational state resulting in satisfactory electrolyte mixing. Filling takes place when the connector (7) from the tank is connected to the coupling (6) on the battery.

2.1.1 If manual connection is used the battery should only be connected to the filling system once a week.

2.1.2 If automatic coupling is used (with a magnetic valve controlled by the charging apparatus) the charger main switch selects the correct moment for filling.

Note: In this case we recommend water refilling at least once a week to ensure the correct level of the electrolyte.

2.1.3 In multiple shift and warm ambient temperature operations, it may be necessary to have shorter topping up intervals.

2.2 Filling time

Filling time depends on the utilization rate and the corresponding battery temperature. Generally speaking, the top up process takes a few minutes and can vary according to the battery range.

2.3 Working pressure

The water refilling system should be installed in such a way that a water pressure of 0.2 to 0.6 bar is obtained (with at least 2 m height difference between the upper edge of the battery and the lower edge of the tank). Any deviation from this means that the system will not function properly.

2.4 Purity

The topping up water must be purified. The water used to refill the batteries must have a conductance of not more than 30 $\mu\text{S/cm}$. The tank and pipes must be cleaned before operating the system.

2.5 Pipe system on the battery

The pipe system to the individual battery cells must follow the battery's electrical circuit. This reduces the risk of current leakage in the presence of electrolytic gas causing an explosion (EN 62485-3). A maximum of 20 cells may be connected in a series.

The system should not be modified in any way.

2.6 Working temperature

In winter, batteries fitted with a water refilling system should only be charged or refilled in a room temperature above 0°C.

2.7 Flow control

A flow indicator built into the water supply pipe to the battery monitors the filling process. During filling the water, flow causes the built-in disc in the flow indicator to turn.

When all the plugs are closed the disc stops, indicating that the filling process is complete.

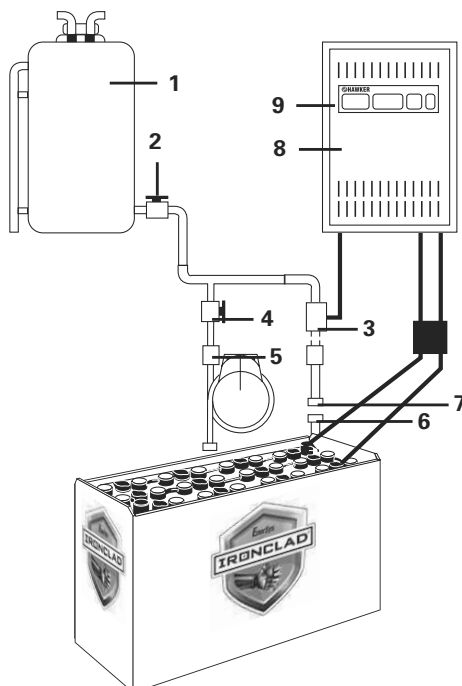

1. Tank
2. Outflow connector with ball valve
3. Plug with magnetic valve
4. Plug with ball valve
5. Flow control
6. Coupling
7. Connector
8. Battery charger
9. Charger main switch

Electrolyte circulation system

1. Application

The electrolyte circulation system is based on the principle of pumping air into the individual battery cells. This system prevents electrolyte stratification and the battery charge is optimised. The electrolyte circulation is particularly beneficial for short charge times, boost or opportunity charging.

2. Function

The electrolyte circulation consists of a pipe system fitted in the cells. A diaphragm pump is fitted in the charger or separately mounted on the battery or vehicle. This diaphragm pump sends a low rate airflow into each cell which creates a circulating air stream inside the cell box. The air stream is continuous or pulsed depending on the battery voltage and pump type. The air supply is adjusted in accordance to the number of cells in the battery.

The pipe system to the individual battery cells must follow the existing electrical circuit. This reduces the risk of current leakage in the presence of electrolytic gas causing an explosion (EN 62485-3).

2.1 Use with separate pipe system

Air is supplied when the charger pipe system is connected to the battery pipe system (with blue ring).

2.2 Use with automatic connection of the pipe system

Connecting the charge plug with integrated air supply automatically supplies air to the battery.

2.3 Maintenance of air filter

Depending on the working conditions, the pump air filter should be changed at least once a year. In work areas with high levels of air-pollution, the filter should be checked and replaced more frequently.

2.4 Repair and maintenance

The system must be checked for leakage. The charger will display an error message to indicate leakage.

Sometimes in the case of leakage, the characteristic charging curve is switched over to the characteristic standard curve (without electrolyte circulation).

Faulty parts and faulty pipe sections must be replaced. Only EnerSys® original spare parts may be used, as these are designed for the pump air supply and will ensure correct functioning of the pump.

Wi-iQ® Battery Monitoring Device

Wi-iQ monitoring device – will provide indications according to the table below.

Tricolour LED
Green blinking = hardware OK Blue rapid blinking = wireless identification Red blinking = temperature warning > 55°C
Blue LED
Rapid blinking = wireless identification Slow blinking = voltage balance warning OFF – Flashing = electrolyte level OK Light is on constantly = electrolyte level low

The Wi-iQ monitoring device is the electronic device that communicates wirelessly to download the battery key information for better diagnostics & service. The device is fitted to a main DC cable on the battery to monitor and record data of current, voltage, temperature and electrolyte level (via optional external sensor). The LEDs on the Wi-iQ monitoring device provide real time status of battery's condition. The information is transferred to the PC via USB by wireless communication.

1. Operation

The Wi-iQ monitoring device is suitable for use on all battery technologies Voltage range is 24V – 120V.

The PC software program can analyze the data: state of charge, temperature warnings and low electrolyte level warnings.

2. Clear visibility

Selecting the Exception & Detailed Reports will provide information on the condition of your battery and any actions that are necessary. Wi-iQ Report will quickly enable you to get a handle on your battery fleet charging & discharging characteristics. With information by battery family (truck type), you can see depth of discharge charts, cycles, charging and much more.

3. Very easy to use

Plug in USB modem to the PC; scan the Wi-iQ monitoring device and up-load the data. Wi-iQ Report is a PC Software running on Windows. A USB wireless key is used for downloading Wi-iQ data in to a SQL database.

Declaration of Conformity

ENERSYS SARL Rue Alexander Fleming ZI Est -CS 40962 F-62033 Arras Cedex- France declares under our sole responsibility that the product:

Product Name: Wi-iQ3

Models: **W3-100**
WCS-1
WCS-2
WCS-3

to which this declaration relates, is in conformity with the following normative European and International standards:

- **EMC Regulations 2016 (S.I. 2016/1091)**
- **Directive 2014/30/EU:**
 - Electromagnetic compatibility
 - BS EN 12895 : 2015 / AI : 2019
- **Directive 2011/65/EU:**
 - RoHS
- **Radio Equipment Regulations 2017 (S.I. 2017 /1206)**
- **Directive 2014/53/EU:**
 - ETSI EN 301489-1 V2.1.1 (2017)
 - ETSI EN 301489-17 V3.1.1 (2017)
 - ETSI EN 300 328 V2.2. 2 (2019)

Date : 28/10/2022
Name : David Letombe
Title : Senior Director Engineering Electronics Systems
Signature 

Declaration of Conformity

ENERSYS SARL Rue Alexander Fleming ZI Est -CS 40962 F-62033 Arras Cedex- France declares under our sole responsibility that the product:

Product Name: Wi-iQ4

Models: **WIIQ4-101**
WIIQ4-102
WIIQ4-202
B84-132
8B4-232

to which this declaration relates, is in conformity with the following normative European and International standards:

- **Electrical Equipment (Safety) Regulations 2016 (S.I. 2016/1101)**
- **Directive 2014/35/EU:**
 - Safety
 - BS EN 61010-1: 2010 / AI : 2019
- **EMC Regulations 2016 (S.I. 2016/1091)**
- **Directive 2014/30/EU:**
 - Electromagnetic compatibility
 - BS EN 12895 : 2015 / AI : 2019
- **Directive 2011/65/EU:**
 - RoHS
- **Radio Equipment Regulations 2017 (S.I. 2017 /1206)**
- **Directive 2014/53/EU:**
 - ETSI EN 301489-1 V2.2.3 (2019)
 - ETSI EN 301489-17 V3.2.2 (2019)
 - ETSI EN 300 328 V2.2. 2 (2019)

Date : 28/10/2022
Name : David Letombe
Title : Senior Director Engineering Electronics Systems
Signature 

Subject to technical modification without any prior notice. E.&O.E.

Back to the manufacturer!

Batteries with this sign must be recycled.
Batteries that are not returned for the recycling process must be disposed of as hazardous waste!

When using motive power batteries and chargers, the operator must comply with the current standards, laws, rules, and regulations in force in the country of use!



Pb

